

# Ordering Guide (C2 Series)

19" Rack Mount

Welded

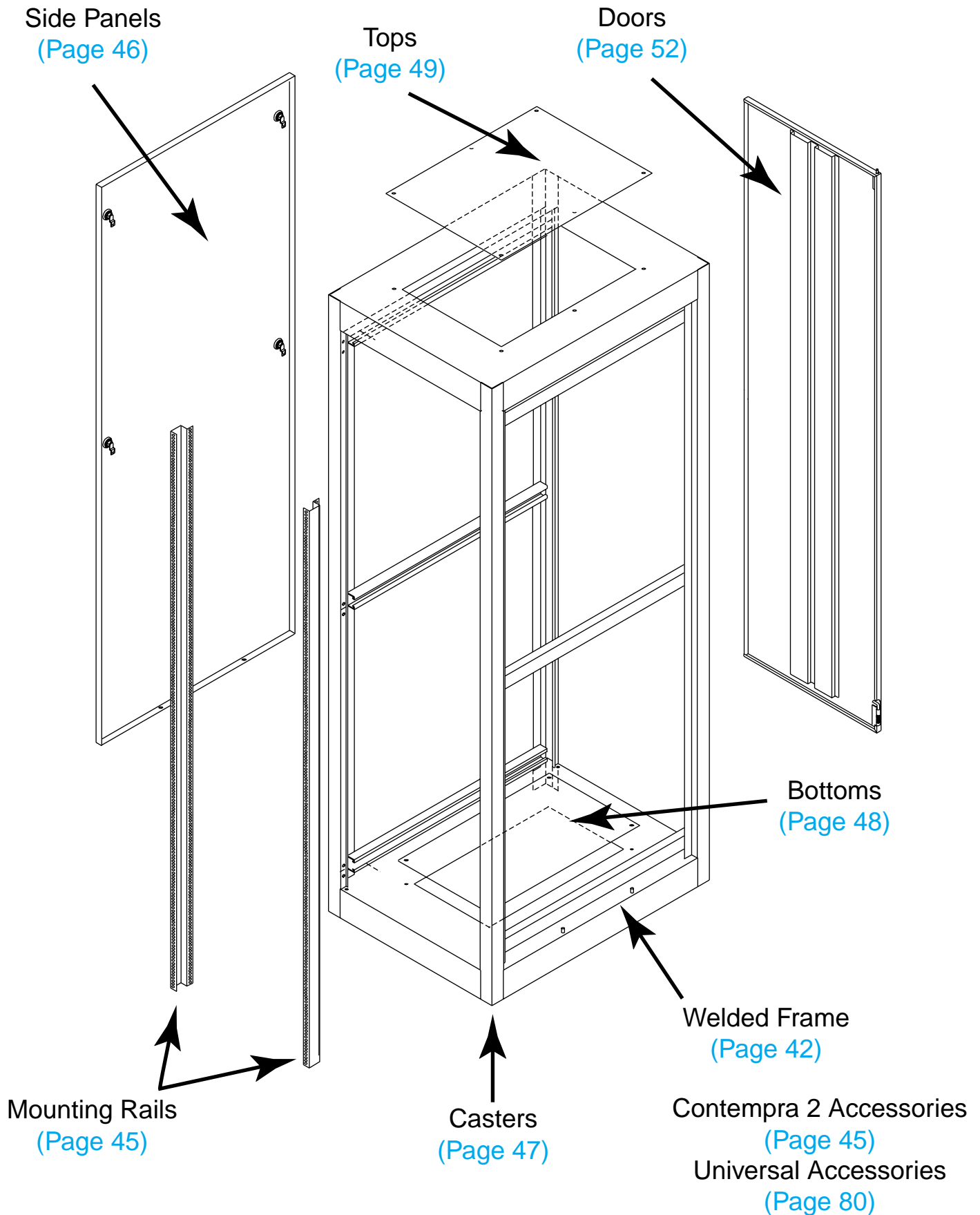

# Panel Rails (C2 Series)

## TAPPED RAILS

- **SOLD IN PAIRS**
- Drilled and tapped (10-32)
- Heavy duty construction - formed from 10 gauge steel
- Full EIA hole centers (5/8 - 5/8 - 1/2 inch spacing)
- Bolts vertically in cabinet to amhal struts
- Includes strut mounting hardware, panel mounting hardware available on page 119
- Zinc plated finish
- Front of rail allows for 19" panel rack mounting
- Rear of rail flange for rear equipment support or accessory mounting



Part Number (Sold in Pairs)	Panel Height	
	Inches	Units
CCR35TZPL	35.00	20
CCR42TZPL	42.00	24
CCR49TZPL	49.00	28
CCR56TZPL	56.00	32
CCR63TZPL	63.00	36
CCR70TZPL	70.00	40
CCR78TZPL	78.75	45
CCR85TZPL	85.75	49

## SQUARE HOLE RAILS

- **SOLD IN PAIRS**
- Square hole punched - allowing choice of hardware for 10-32 or 12-24 or M6 thread cage nuts)
- Includes a starter quantity (25) of 10-32 cage nuts
- Heavy duty construction - formed from 12 gauge steel
- Full EIA hole centers (5/8 - 5/8 - 1/2 inch spacing)
- Bolts vertically in cabinet to amhal struts
- Includes strut mounting hardware, panel mounting hardware available on page 119
- Zinc plated finish
- Front of rail allows for 19" panel rack mounting
- Rear "L" of rail for rear equipment support or accessory mounting



19" Rack Mount

Welded



Cage Nut  
Installation Tool

- Allows for easy installation of cage nuts in square rail hole
- Spring steel tool
- Part Number **RCNIT**

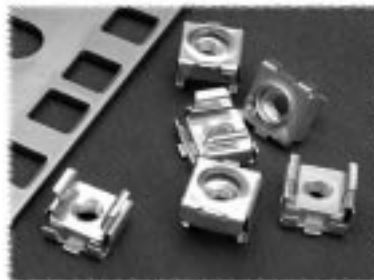

Additional Cage Nuts

Part Number	Qty. Per Package	Thread
1421CNA25	25	10-32
1421CNA100	100	10-32
1421CNC25	25	12-24
1421CNC100	100	12-24
1421CNB25	25	M6
1421CNB100	100	M6

Part Number (Sold in Pairs)	Panel Height	
	Inches	Units
CPR35SZPL	35.00	20
CPR42SZPL	42.00	24
CPR49SZPL	49.00	28
CPR56SZPL	56.00	32
CPR63SZPL	63.00	36
CPR70SZPL	70.00	40
CPR78SZPL	78.75	45
CPR85SZPL	85.75	49



# Side Panels (C2 Series)

## SIDE PANELS



### FEATURES

- Sold in pairs
- Constructed of 16 gauge steel
- Panels fit flush with frame
- Designed for easy removal and installation
- Features quick release 1/4 turn cam fasteners (4 per side) with internal latching provision
- Two pins on the bottom of the frame allow for easy alignment & installation
- Finished in a rugged textured powder paint

### 23.63" Deep

Part Number		Depth (Inches)	Panel Height	
Black Textured	Beige Textured		Inches	Units
CSP3523BK1	CSP3523CG1	23.63	35.00	20
CSP4223BK1	CSP4223CG1	23.63	42.00	24
CSP4923BK1	CSP4923CG1	23.63	49.00	28
CSP5623BK1	CSP5623CG1	23.63	56.00	32
CSP6323BK1	CSP6323CG1	23.63	63.00	36
CSP7023BK1	CSP7023CG1	23.63	70.00	40
CSP7823BK1	CSP7823CG1	23.63	78.75	45
CSP8523BK1	CSP8523CG1	23.63	85.75	49

### 31.5" Deep

Part Number		Depth (Inches)	Panel Height	
Black Textured	Beige Textured		Inches	Units
CSP3531BK1	CSP3531CG1	31.50	35.00	20
CSP4231BK1	CSP4231CG1	31.50	42.00	24
CSP4931BK1	CSP4931CG1	31.50	49.00	28
CSP5631BK1	CSP5631CG1	31.50	56.00	32
CSP6331BK1	CSP6331CG1	31.50	63.00	36
CSP7031BK1	CSP7031CG1	31.50	70.00	40
CSP7831BK1	CSP7831CG1	31.50	78.75	45
CSP8531BK1	CSP8531CG1	31.50	85.75	49

### 36" Deep

Part Number		Depth (Inches)	Panel Height	
Black Textured	Beige Textured		Inches	Units
CSP3536BK1	CSP3536CG1	36.00	35.00	20
CSP4236BK1	CSP4236CG1	36.00	42.00	24
CSP4936BK1	CSP4936CG1	36.00	49.00	28
CSP5636BK1	CSP5636CG1	36.00	56.00	32
CSP6336BK1	CSP6336CG1	36.00	63.00	36
CSP7036BK1	CSP7036CG1	36.00	70.00	40
CSP7836BK1	CSP7836CG1	36.00	78.75	45
CSP8536BK1	CSP8536CG1	36.00	85.75	49

## SIDE PANEL LOCKS



- For higher security, the quarter turn fasteners on the side panels can be replaced with this key locking version
- Order part number **CSPQTRL**
- Kit contains 4 quarter turn locks and 8 keys.
- Good for 1 rack (ie...2 locks per side panel)

19" Rack Mount

Welded

## LIGHT DUTY CASTERS

- **Light Duty** - 360 lbs. Mfg.'s specified weight capacity (Set of 4)
- Features ball bearing swivel and hard composition wheels
- Standard 3" x 1.75" hole mounting pattern - no drilling required
- Adds only 0.75" to height of cabinet by fitting up inside base of rack
- Wheels are black & 3" wheel diameter
- Includes mounting hardware
- **SOLD IN A SET OF 4**
- Part Number **1425B**



## MEDIUM DUTY CASTERS

- **Medium Duty** - 700 lbs. Mfg.'s specified weight capacity (Set of 4)
- Features ball bearing swivel and hard composition wheels
- Standard 3" x 1.75" hole mounting pattern
- Adds only 0.75" to height of cabinet by fitting up inside base of rack
- Wheels are black & 3" wheel diameter
- Includes mounting hardware
- **SOLD IN A SET OF 4**
- Part Number **1425BM**



## HEAVY DUTY CASTERS

- **Heavy Duty** - 1,050 lbs. Mfg.'s specified weight capacity (Set of 4)
- Features ball bearing swivel and hard composition wheels
- Standard 3" x 1.75" hole mounting pattern
- Adds only 0.75" to height of cabinet by fitting up inside base of rack
- Wheels are blue & 3" wheel diameter
- Includes mounting hardware
- **SOLD IN A SET OF 4**
- Part Number **1425BH**



## LOCKING CASTERS

- These are exterior mount casters that mount outside of rack frame perimeter to allow foot access of locking pedals
- **Medium Duty** - 560 lbs. Mfg.'s specified weight capacity (Set of 4)
- Available in either locking or non-locking format
- Sold in **pairs** allowing for mix of locking and nonlocking on same cabinet
- 3.5" diameter wheels add 4.88" to cabinet height
- No drilling required as casters fit into built-in caster mounts
- Part Number **CCSTL** for a PAIR of locking casters
- Part Number **CCSTN** for a PAIR of non-locking casters



19" Rack Mount

Welded



Hammond Manufacturing Co. Ltd.  
394 Edinburgh Rd. North  
Guelph, Ontario N1H 1E5 CANADA  
© Phone: 519-822-2960 Fax: 519-822-0715



Hammond Manufacturing Co. Inc.  
256 Sonwil Dr.  
Cheektowaga, NY 14225 USA  
Phone: 716-651-0086 Fax: 716-651-0726

# Bottom Options (C2 Series)

## FRAME BOTTOMS

- 14 gauge steel construction
- Micro Cell Cable Entry Bottom features 2 cutouts for cable access. Under side of cutouts covered with black foam rubber which, when punctured for cable access, still maintains a virtually sealed bottom
- Mounting hardware included

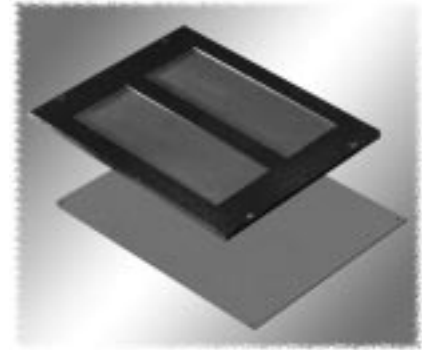

Micro Cell Cable Entry or Solid Steel (pictured top to bottom)

Micro Cell Cable Entry Bottom

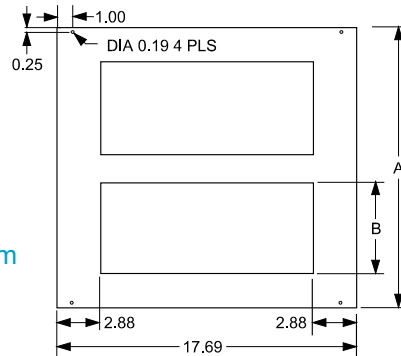

Part Number		Type	Dimensions (Inches)			
Black Textured	Beige Textured		Panel Width	A	B	Rack Depth
<a href="#">C2BPS1923BK1</a>	<a href="#">C2BPS1923CG1</a>	Solid	19	11.5	-	23.63
<a href="#">C2BPS1931BK1</a>	<a href="#">C2BPS1931CG1</a>	Solid	19	18.5	-	31.50 or 36.00
<a href="#">C2BPCE1923BK1</a>	<a href="#">C2BPCE1923CG1</a>	Cable Entry	19	11.5	3.5	23.63
<a href="#">C2BPCE1931BK1</a>	<a href="#">C2BPCE1931CG1</a>	Cable Entry	19	18.5	6.0	31.50 or 36.00

19" Rack Mount

Welded

## PLINTH

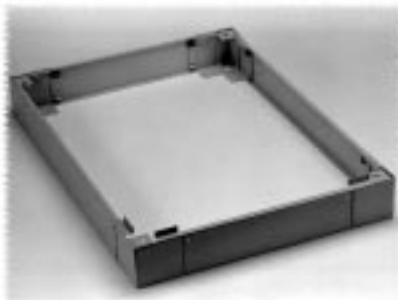

- Adds 4" to overall rack height
- 14 gauge steel construction
- Features 4 corner units and 4 removable fill panels
- By removing both front & rear panels, easy access to bottom cabling and forklift lifting/transport are achieved
- Not compatible with levelling feet or casters

## BOLT DOWN KIT

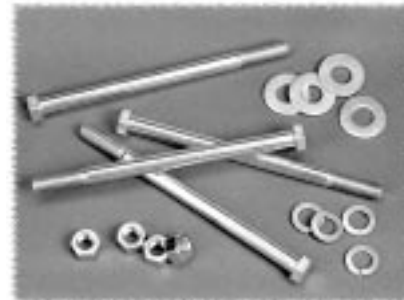

- Fixes rack to floor
- Kit includes set of four - 3/8" x 5 1/2" bolts with flat washers and nuts
- Can be used with or without plinths
- Part Number: **CBDK4**

Part Number		Panel Width	Use with Frame Depth
Black Textured	Beige Textured		
<a href="#">CPL19423BK1</a>	<a href="#">CPL19423CG1</a>	19"	23.63"
<a href="#">CPL19431BK1</a>	<a href="#">CPL19431CG1</a>	19"	31.50"
<a href="#">CPL19436BK1</a>	<a href="#">CPL19436CG1</a>	19"	36.00"

## SOLID TOP

- 14 gauge steel construction
- Supplied with mounting hardware
- Should be used on all racks where protection from dust or falling objects is required

Part Number		Panel Width	Rack Depth
Black Textured	Beige Textured		
C2T1923SBK1	C2T1923SCG1	19	23.63
C2T1931SBK1	C2T1931SCG1	19	31.50
C2T1936SBK1	C2T1936SCG1	19	36.00



## VENTED TOP

- 14 gauge steel construction
- Supplied with mounting hardware
- Provides a practical and economical solution to convection cooling requirements
- Available either with or without 3.5" cable access holes and covers

### Without Cable Access Holes

Part Number		Panel Width	Rack Depth
Black Textured	Beige Textured		
C2T1923VBK1	C2T1923VCG1	19	23.63
C2T1931VBK1	C2T1931VCG1	19	31.50
C2T1936VBK1	C2T1936VCG1	19	36.00

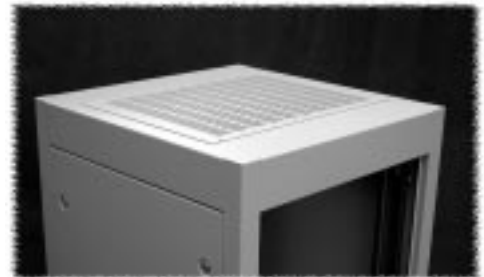

### With 3.5" Cable Access Holes & Covers

Part Number		Panel Width	Rack Depth
Black Textured	Beige Textured		
C2T1923VCEBK1	C2T1923VCECG1	19	23.63
C2T1931VCEBK1	C2T1931VCECG1	19	31.50
C2T1936VCEBK1	C2T1936VCECG1	19	36.00



19" Rack Mount

Welded

## RAISED VENT TOP

- 14 gauge steel construction
- Supplied with mounting hardware
- Simple up or down adjustment permits either raised installation for venting or flush mounting for smooth decorative look
- Allows for protection from falling objects or liquids
- When raised, permits convection cooling as gap between top & frame allows warm air to escape on all four sides

Part Number		Panel Width	Rack Depth
Black Textured	Beige Textured		
C2T1923RBK1	C2T1923RCG1	19	23.63
C2T1931RBK1	C2T1931RCG1	19	31.50
C2T1936RBK1	C2T1936RCG1	19	36.00



# Fan Tops (C2 Series)

## 4.7" FAN TOP PANEL

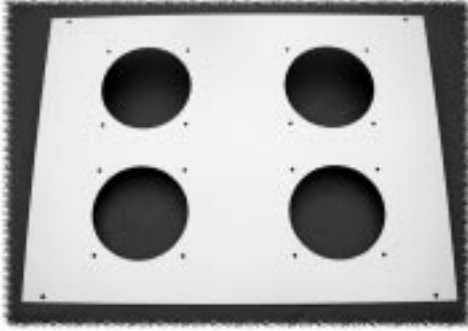

- 14 gauge steel construction
- 4.7" fan top panel - fans not included (see next page)
- Quantity 4 or 6 openings depending on depth of rack
- Maximum flexibility - add fans, leave holes open (for cable access) or use covers (see next page)

Part Number		Panel Width	Rack Depth	Fan Holes
Black Textured	Beige Textured			
C2T1923FBK1	C2T1923FCG1	19	23.63	4
C2T1931FBK1	C2T1931FCG1	19	31.50	6
C2T1936FBK1	C2T1936FCG1	19	36.00	6

## PRE-WIRED 4.7" EXHAUST FAN TOP



- Includes a quantity of 4 - long life, ball bearing, 4.7", 115 volt, 50/60 Hz. AC, 100 CFM fans (230 VAC fan tops available on special order)
- Available with or without thermostat
- Finger guards are punched into top panel and bottom of fan top
- Fans are pre-wired, installed and complete with 3 foot cord & plug

Part Number		Panel Width	Rack Depth	Thermostat
Black Textured	Beige Textured			
C2T1923F4BK1	C2T1923F4CG1	19	23.63	No
C2T1931F4BK1	C2T1931F4CG1	19	31.50	No
C2T1936F4BK1	C2T1936F4CG1	19	36.00	No
C2T1923F4TBK1	C2T1923F4TCG1	19	23.63	Yes
C2T1931F4TBK1	C2T1931F4TCG1	19	31.50	Yes
C2T1936F4TBK1	C2T1936F4TCG1	19	36.00	Yes

## PRE-WIRED 10" EXHAUST FAN TOP PANEL



Without Cable Access

- Includes quantity 1 - 10", 550 CFM, 115 V 50/60 Hz. AC fan 35 watt motor (230 VAC fan tops available on special order)
- Thermal protected motor
- Ball bearing construction, plastic blades (3)
- Diecast aluminum body fan
- Rotation is clockwise (looking down at the rotor - as pictured on the left)
- Airflow exhausts the rack (out the top as pictured on the left)
- C UL & UL recognized
- 5' cord and molded on plug
- Top & bottom finger guards included
- Pre-wired and assembled as shown
- Available either with or without 4 cable access holes (3.5") and covers

### Without Cable Access Holes

Part Number		Panel Width	Rack Depth
Black Textured	Beige Textured		
C2T1923F10BK1	C2T1923F10CG1	19	23.63
C2T1931F10BK1	C2T1931F10CG1	19	31.50
C2T1936F10BK1	C2T1936F10CG1	19	36.00

### With Cable Access 3.5" Holes & Covers

Part Number		Panel Width	Rack Depth
Black Textured	Beige Textured		
C2T1923F10CEBK1	C2T1923F10CECG1	19	23.63
C2T1931F10CEBK1	C2T1931F10CECG1	19	31.50
C2T1936F10CEBK1	C2T1936F10CECG1	19	36.00

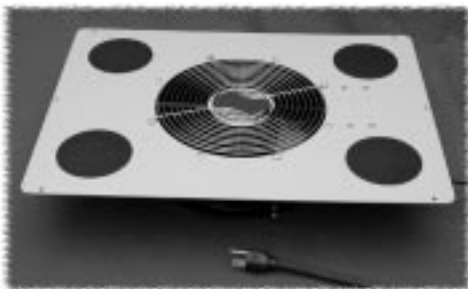

With Cable Access

19" Rack Mount

Welded

# Fan Top Accessories (C2 Series)

## 4" FANS

- 4.70" (120mm), 1.50" deep - Tubeaxial type
- Choice of either 115 or 230 VAC, 50/60 Hz.
- Impedance protected motor Class-B insulated
- Ball bearing construction, metal blades
- Diecast aluminum body
- Rotation is counter clockwise (looking at the rotor - as pictured)
- Airflow is over the struts (out the back as pictured)
- Male plug terminated (requires fan cords below)
- UL recognized, CSA listed, CE certified
- With mounting hardware

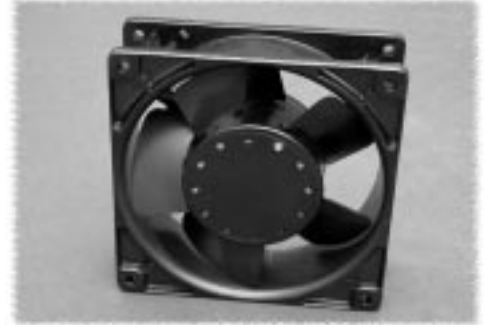

Part Number	Size		VAC	CFM	Wattage	Use With Fan Guard Part Number
	Inches	mm				
<a href="#">DNMF100AC115</a>	4.70	120	115	105	22	DNFG
<a href="#">DNMF100AC230</a>	4.70	120	230	105	22	DNFG

## METAL FAN GUARDS

- Constructed of steel
- For covering unused fan top openings or as 4.7" fan guards
- Hardware included

Part Number	Color	Use with Fan Size
<a href="#">DNFG</a>	Wire mesh, nickel plated	4.7"



## 4.7" FAN HOLE COVER

- Constructed of 14 gauge steel
- For covering unused fan top openings on 4.7" fan tops
- Hardware included

Part Number	Color	Paint Finish
<a href="#">DNFPBK1</a>	Black	Textured
<a href="#">DNFPCG1</a>	Grey-Beige	Textured

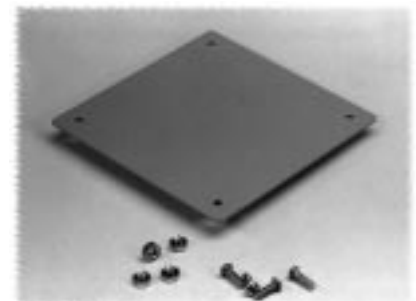

## FAN CORD

- For 115 VAC wiring
- Standard molded female fan plug (0.91" x 0.68")

Part Number	Description	Lead Length	Fan Connector	115VAC Plug
<a href="#">DNMFC</a>	Single Fan Cord	24"	Straight	No
<a href="#">DNFC48P</a>	Single Fan Cord	48"	45 degree	Yes
<a href="#">DNFC72P</a>	Single Fan Cord	72"	45 degree	Yes
<a href="#">DNFCDC2P</a>	Daisy Chain	24"	Qty. 2- 45 degree, 24" apart	Yes
<a href="#">DNFCDC3P</a>	Daisy Chain	24"	Qty 3 - 45 degree, 24" apart	Yes



19" Rack Mount

Welded



Hammond Manufacturing Co. Ltd.  
394 Edinburgh Rd. North  
Guelph, Ontario N1H 1E5 CANADA  
© Phone: 519-822-2960 Fax: 519-822-0715



Hammond Manufacturing Co. Inc.  
256 Sonwil Dr.  
Cheektowaga, NY 14225 USA  
Phone: 716-651-0086 Fax: 716-651-0726



# Doors (C2 Series)

## SOLID DOOR



- Flush mount
- Heavy duty 16 gauge steel construction with sturdy door stiffeners welded on
- Reversible right or left opening (by inverting door)
- Features lockable latch, magnetic catch and spring loaded hinge pins for instant installation or removal
- Allows full access to space between panel rails when open
- Paint matches rack in the same rugged textured baked enamel finish

Part Number		Panel Height		Use With 19" Frame Part Number
Black Textured	Beige Textured	Inches	Units	
<a href="#">CDF1935SBK1</a>	<a href="#">CDF1935SCG1</a>	35.00	20	C2F1935
<a href="#">CDF1942SBK1</a>	<a href="#">CDF1942SCG1</a>	42.00	24	C2F1942
<a href="#">CDF1949SBK1</a>	<a href="#">CDF1949SCG1</a>	49.00	28	C2F1949
<a href="#">CDF1956SBK1</a>	<a href="#">CDF1956SCG1</a>	56.00	32	C2F1956
<a href="#">CDF1963SBK1</a>	<a href="#">CDF1963SCG1</a>	63.00	36	C2F1963
<a href="#">CDF1970SBK1</a>	<a href="#">CDF1970SCG1</a>	70.00	40	C2F1970
<a href="#">CDF1978SBK1</a>	<a href="#">CDF1978SCG1</a>	78.75	45	C2F1978
<a href="#">CDF1985SBK1</a>	<a href="#">CDF1985SCG1</a>	85.75	49	C2F1985

## LOUVERED DOOR



- Flush mount
- Heavy duty 16 gauge steel construction with sturdy door stiffeners welded on
- Opens right hand only with louvers facing down
- Features lockable latch, magnetic catch and spring loaded hinge pins for instant installation or removal
- Allows full access to space between panel rails when open
- Paint matches rack in the same rugged textured baked enamel finish

Part Number		Panel Height		Use With 19" Frame Part Number
Black Textured	Beige Textured	Inches	Units	
<a href="#">CDF1935LBK1</a>	<a href="#">CDF1935LCG1</a>	35.00	20	C2F1935
<a href="#">CDF1942LBK1</a>	<a href="#">CDF1942LCG1</a>	42.00	24	C2F1942
<a href="#">CDF1949LBK1</a>	<a href="#">CDF1949LCG1</a>	49.00	28	C2F1949
<a href="#">CDF1956LBK1</a>	<a href="#">CDF1956LCG1</a>	56.00	32	C2F1956
<a href="#">CDF1963LBK1</a>	<a href="#">CDF1963LCG1</a>	63.00	36	C2F1963
<a href="#">CDF1970LBK1</a>	<a href="#">CDF1970LCG1</a>	70.00	40	C2F1970
<a href="#">CDF1978LBK1</a>	<a href="#">CDF1978LCG1</a>	78.75	45	C2F1978
<a href="#">CDF1985LBK1</a>	<a href="#">CDF1985LCG1</a>	85.75	49	C2F1985

## PLEXI DOOR



- Flush mount
- 16 gauge steel door frame with smoked plexi glass insert
- Reversible right or left opening (by inverting door)
- Features lockable latch, magnetic catch and spring loaded hinge pins for instant installation or removal
- Allows full access to space between panel rails when open
- Frame painted with rugged textured black powder paint

Part Number	Panel Height		Use With 19" Frame Part Number
	Black Flush Plexi	Inches	
<a href="#">C2DF1935PBK1</a>	35.00	20	C2F1935
<a href="#">C2DF1942PBK1</a>	42.00	24	C2F1942
<a href="#">C2DF1949PBK1</a>	49.00	28	C2F1949
<a href="#">C2DF1956PBK1</a>	56.00	32	C2F1956
<a href="#">C2DF1963PBK1</a>	63.00	36	C2F1963
<a href="#">C2DF1970PBK1</a>	70.00	40	C2F1970
<a href="#">C2DF1978PBK1</a>	78.75	45	C2F1978
<a href="#">C2DF1985PBK1</a>	85.75	49	C2F1985

19" Rack Mount

Welded

## PERFORATED DOOR

- Flush mount
- Provides maximum ventilation while maintaining security
- Heavy Duty 16 gauge steel construction with perforated steel inserts
- Reversible right or left opening (by inverting door)
- Features lockable latch, magnetic catch and spring loaded hinge pins for instant installation or removal
- Allows full access to space between panel rails when open
- Paint matches "C2" type rack frame in the same rugged textured powder paint finish.



Part Number		Panel Height		Use With 19" Frame Part Number
Black Textured	Beige Textured	Inches	Units	
<a href="#">CDF1970VBK1</a>	<a href="#">CDF1970VCG1</a>	70.00	40	C2F1970
<a href="#">CDF1978VBK1</a>	<a href="#">CDF1978VCG1</a>	78.00	45	C2F1978

## VENTILATED PLEXI DOOR

- Flush mount
- Provides airflow through cabinet and excellent equipment visibility
- 16 gauge steel door frame (ventilated) with smoked plexi glass insert
- Reversible right or left opening (by inverting door)
- Features lockable latch, magnetic catch and spring loaded hinge pins for instant installation or removal
- Allows full access to space between panel rails when open
- Complete with keyed lock and magnet strip for closure
- Frame is painted with a rugged textured black powder paint finish.



Part Number		Panel Height		Use With 19" Frame Part Number
Black Textured	Beige Textured	Inches	Units	
<a href="#">CDF1970VPBK1</a>	<a href="#">CDF1970VPCG1</a>	70.00	40	C2F1970
<a href="#">CDF1978VPBK1</a>	<a href="#">CDF1978VPCG1</a>	78.00	45	C2F1978

19" Rack Mount

## PARTIAL HEIGHT DOOR SUPPORT

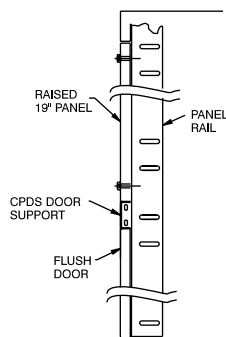

- Allows partial height door installation (used when blowers are installed in bottom of rack)
- Requires drilling of rack frame
- Occupies 1.75" (1U) of panel height
- Door support is 0.75" deep

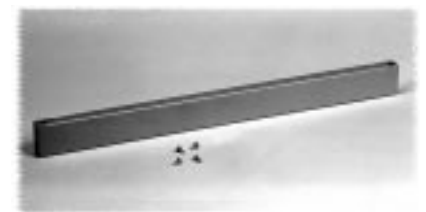

Part Number		For Panel Width
Black Textured	Beige Textured	
<a href="#">CPDS19BK1</a>	<a href="#">CPDS19CG1</a>	19"

Welded



# Exclusive Accessories (C2 Series)

## GANGING KIT



- Complete hardware kit allowing two racks to be ganged at six points along vertical frame side.
- Part Number **CGH01**

## EXTRA LEVELLING FEET



- Contempra racks all **INCLUDE** 4 nylon base levelling feet
- Set of 4
- Four levelling feet will support a maximum of 800 lbs.
- Part Number **CLFK** for standard nylon base
- Part Number **CLFKNS** for nonskid rubber base

## GROUND BUS BARS



Part Number	Use With Rack Part Number
<b>CBB35</b>	C2F1935
<b>CBB42</b>	C2F1942
<b>CBB49</b>	C2F1949
<b>CBB56</b>	C2F1956
<b>CBB63</b>	C2F1963
<b>CBB70</b>	C2F1970
<b>CBB78</b>	C2F1978
<b>CBB85</b>	C2F1985

- Full length copper strip 0.13" x 0.63"
- Includes hardware for mounting on rack frame side struts

## LEVELLING FOOT WRENCH



- Laser cut flat steel wrench
- Designed for easy levelling under frame
- Part Number **RFLW**

## DESK UNIT



- Constructed of beige laminate and 14 gauge steel support channels
- Ideal for writing surface, keyboard or instrument mounting requirements
- Mounts onto rails, but is notched on both sides for flush fit with cabinet sides.
- Part Number **CW19CG4**

## TRIM KIT



- Extruded aluminum dress kit with black inlay (ideal for custom identification)
- Attaches with strong adhesive requiring no drilling or hardware
- Compatible with flush doors only
- Part Number **C2ID19**

## BLOWER ADAPTER KIT



- This blower mounting kit mounts flush with both the rack frame face and any flush door
- Allows use of 5.25" (3U) blowers
- Also used for cable access where large bundles of wires are used

Part Number		For Use with Flush Door Part Number	For Panel Height	
Black Textured	Beige Textured		Inches	Units
<b>CBA1975BK1</b>	<b>CBA1975CG1</b>	CDF1935 or C2DF1935	42.00	24
<b>CBA1975BK1</b>	<b>CBA1975CG1</b>	CDF1942 or C2DF1942	49.00	28
<b>CBA1975BK1</b>	<b>CBA1975CG1</b>	CDF1949 or C2DF1949	56.00	32
<b>CBA1975BK1</b>	<b>CBA1975CG1</b>	CDF1956 or C2DF1956	63.00	36
<b>CBA1975BK1</b>	<b>CBA1975CG1</b>	CDF1963 or C2DF1963	70.00	40
<b>CBA1985BK1</b>	<b>CBA1985CG1</b>	CDF1970 or C2DF1970	78.75	45

19" Rack Mount

Welded